

design: R&D

N10-65 N10-E

LAM32
IDEASBECOMINGLIGHT

Apparecchio pensato per l'installazione in appoggio su pareti e soffitti in cartongesso o muratura per mezzo di appositi accessori. Finalizzato all'impiego di sorgenti LED di diversa potenza, ha corpo realizzato in alluminio estruso anodizzato completamente riempito di speciale resina opale resistente ai raggi UV, per garantire il massimo livello di performance, comfort visivo e pulizia nel tempo. Tappi terminali di chiusura in alluminio anodizzato. L'apparecchio è fornito con uscita del cavo di alimentazione posteriore. Dotato di 50 cm di cavo per il collegamento alla linea di alimentazione 24VDC. Alimentatore elettronico 24VDC da ordinare come accessorio.

Luminaire designed for surface installation on walls and false ceilings using appropriate accessories. Suitable for LED sources of different powers, their bodies are made of anodized extruded aluminium, full filled with a special opal resin, resistant to UV rays, to ensure the maximum level of performance, visual comfort and cleanness over time. Closing end caps are made of anodized aluminium. The luminaires are supplied with rear cable output. It is equipped with a 50cm long cable for connection to the 24VDC power supply line. 24VDC Electronic driver to be ordered as an accessory.

N10 - 65



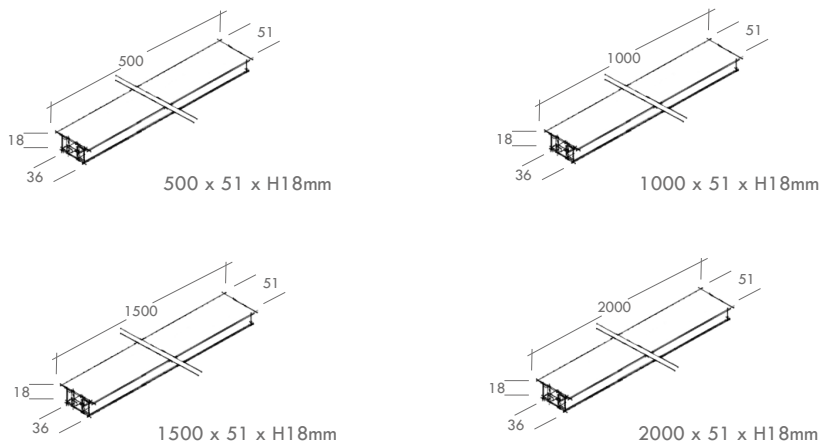

DISEGNO TECNICO/TECHNICAL DRAWING



nome/name	misura/dimension	codice/code	sorgente/lamp	lumen/lumens		
				2700K	3000K	4000K
N10 -65	500	04.104646	LED 2x9,5W	1440	1520	1600
N10 -65	1000	04.104647	LED 2x19W	2880	3040	3200
N10 -65	1500	04.104648	LED 2x28,5W	4320	4560	4800
N10 -65	2000	04.104649	LED 2x38W	5760	6080	6400

ACCESSORI/ACCESSORIES

codice/code

	20.104652	Tappo di chiusura / Closing end cap Dimens. 18 x 51 x 2 (mm)
	20.104653	Coppia di clip di fissaggi / Pair of fixing clips

ESEMPIO COMPOSIZIONE CODICE/EXAMPLE OF CODE COMPOSITION

Alimentatore elettronico 24VDC e sistemi di connessione da ordinare come accessorio. Elettroniche di controllo, iSmart CV, iColor CV o iDimm CV, da ordinare come accessorio.

Electronic driver and connection systems 24VDC to be ordered as an accessory. Control Electronics, iSmart CV, iColor CV or iDimm CV, to be ordered as accessory.

04.104646.03.DI.BP.P



Fascio luminoso/Light beam

.DI diffuso / diffused

Colore LED/LED Colour

.BC	2700K
.BP	3000K
.BF	4000K
.DW	2800K 6000K

Uscita cavo alimentazione / Cable Output

.P posteriore / rear

FINITURA/FINISH

colore/colour	codice/code
	.03 / alluminio anodizzato anodized aluminium



N10 - E



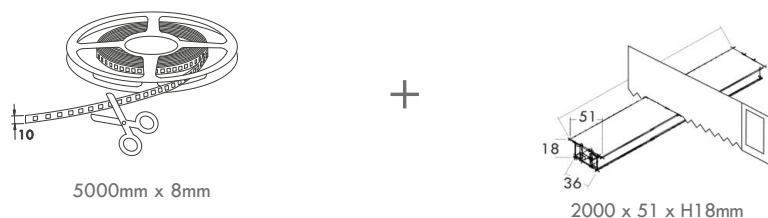

DISEGNO TECNICO/TECHNICAL DRAWING



nome/name	misure/dimension	codice/code	sorgente/lamp	lumen/lumens					
				2200K	2700K	3000K	4000K	DW	RGBW
CIRCUITO LED IN BOBINE/ LED CIRCUIT REEL	5000	30.103514	19,2 W/m	1420	10440	1536	1570	1593	864
N10 - E*	2000	30.104656							

ACCESSORI/ACCESSORIES

codice/code	
	20.104652 Tappo di chiusura / Closing end cap Dimens. 18 x 51 x 2 (mm)
	20.104653 Coppia di clip di fissaggi / Pair of fixing clips

ESEMPIO COMPOSIZIONE CODICE/EXAMPLE OF CODE COMPOSITION

Alimentatore elettronico 24VDC e sistemi di connessione da ordinare come accessorio. Elettroniche di controllo, iSmart CV, iColor CV o iDimm CV, da ordinare come accessorio.

Electronic driver and connection systems 24VDC to be ordered as an accessory. Control Electronics, iSmart CV, iColor CV or iDimm CV, to be ordered as accessory.

Fascio luminoso/Light beam

Led	Colore/Colour	lm/m	Led/m	Taglio/Cut
.DP				diffuso perpendicolare/perpendicular diffused
.XC	2200K	1420	240	25mm
.BC	2700K	1440	240	25mm
.BP	3000K	1536	240	25mm
.BF	4000K	1570	240	25mm
.DW	2800K 6000K	1593**	240	50mm
.RGBW	RGB+W 3000K	864**	60	100mm
Potenza circuito Led/Led circuit power				
.20		19,2W/m		

30.103514.DP.BP.20

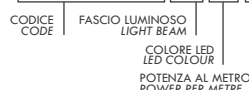

* IK05 - IP40
**Flusso luminoso Full Color. / Full color luminous flux.

FINITURA/FINISH

colore/colour	codice/code
	.03 / alluminio anodizzato anodized aluminium

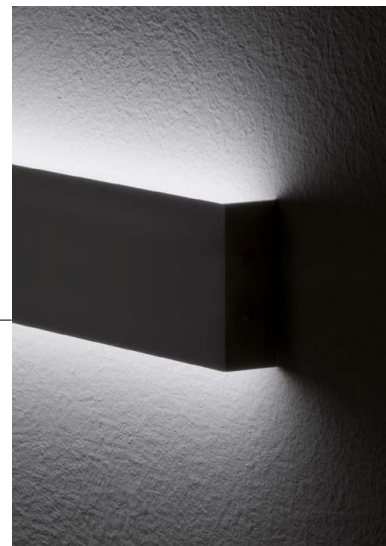

LETTURA DELLA SCHEDA READING THE DATA SHEET

NOME FAMIGLIA
SERIES NAME

MARCHI E REQUISITI
MARKING AND REQUIREMENTS

DISEGNO TECNICO
TECHNICAL DRAWING



BIN

DISEGNO TECNICO/TECHNICAL DRAWING

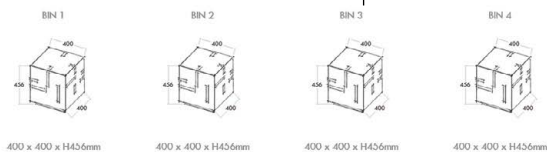

BIN LED	codice/code	sorgente/lamp	lumen/lumens
			3000K 4000K
BIN 1 LUCE/LIGHT	05.101.227	LED 20,5W	2237 2350
BIN 2 LUCE-AUDIO / LIGHT-AUDIO	05.101.228	LED 20,5W	2237 2350
BIN 3 LUCE-WIFI / LIGHT-WIFI	05.101.229	LED 20,5W	2237 2350
BIN 4 LUCE-AUDIO-WIFI / LIGHT-AUDIO-WIFI	05.101.230	LED 20,5W	2237 2350

FINITURA/FINISH

colori/colour	codice/code
	.05 / inox satinato satin stainless
	.04 / verniciato cor-ten painted cor-ten
	.03 / verniciato grigio painted grey
	.02 / verniciato nero painted black
	.01 / verniciato bianco painted white

ACCESSORI/ACCESSORIES

PIASTRA TIRAFONDI/ANCHOR PLATE		
codice/code		
	20.100379	320mm x 320mm H130mm

ESEMPIO COMPOSIZIONE CODICE / EXAMPLE OF CODE COMPOSITION

Alimentatore elettronico 220/240V 50-60Hz integrato nel corpo dell'apparecchio. Electronic driver 220/240V 50-60Hz integrated in the luminaire's body.

05.101.227.01.BP		Colore LED/LED Colour	
BP	3000K	BP	4000K

DESCRIZIONE TECNICA DELL'APPARECCHIO
LUMINAIRE TECHNICAL DESCRIPTION

.08/cemento	.08/concrete
.06/alluminio lucido o inox lucido	.06/polished aluminium or polished stainless
.05/alluminio satinato o inox satinato	.05/satin aluminium or satin stainless
.04/verniciato cor-ten	.04/painted cor-ten
.03 verniciato grigio (RAL 9006) o alluminio anodizzato	.03/painted grey (RAL 9006) or anodized aluminium
.02/verniciato nero (RAL 9005) o anodizzato nero	.02/painted black (RAL 9005) or black anodized
.01/verniciato bianco (RAL 9016)	.01/painted white (RAL 9016)
.00/naturale	.00/natural

FINITURE DISPONIBILI
AVAILABLE FINISHES















TABELLA COMPOSIZIONE CODICE
CODE COMPOSITION TABLE

DESCRIZIONE SORGENTE
LAMP DESCRIPTION

CODICE RADICE APPARECCHIO
LUMINAIRE CODE

SIMBOLOGIA SYMBOLS

Configurazioni disponibili/Available configurations

	Apparecchio disponibile in versione RGB (solo per versioni con min. 3 lampade o versioni LED).	Luminaire available in RGB version (only for versions with a min. of 3 lamps or LED versions).
	Apparecchio disponibile in versione CTC (controllo temperatura di colore, solo per versioni con min. 3 lampade o versioni LED).	Luminaire available in CTC version (colour temperature control, only for versions with a min. of 3 lamps or LED versions).
	Apparecchio con possibilità di dimmerazione.	Luminaire has possibility to be dimmed.
	Apparecchio con possibilità di dimmerazione 0/10.	Luminaire has possibility to be dimmed 0/10.
	Apparecchio con possibilità di dimmerazione DALI.	Luminaire has possibility to be dimmed DALI.
	Apparecchio con possibilità di dimmerazione PWM.	Luminaire has possibility to be dimmed PWM.
	Apparecchio disponibile con apparato di diffusione sonora ad induzione.	Luminaire available with induction sound diffusion system.
	Apparecchio disponibile con Router Wi-Fi interno per la diffusione nello spazio circostante di segnali wire-less di ogni genere.	Luminaire available with internal Wi-Fi Router for the diffusion of any kind of wireless signal in the surrounding space.
	Kit emergenza	Emergency Kit
	Apparecchio personalizzabile (con fattibilità da verificare). Modifiche su richiesta: -finitura RAL -dimensione -tecnologia di comunicazione (DALI, WIFI o AUDIO integrato)	Luminaire customizable (with feasibility to be checked). Changes on request: -RAL finish -size -communication technology (integrated DALI, WIFI or AUDIO)
	Apparecchio disponibile a richiesta in versione RGB (solo per versioni con sorgente LED o con minimo 3 lampade).	Luminaire available, on request, in RGB version (only for LED versions or with a minimum of 3 lamps).
	Apparecchio disponibile a richiesta in versione CTC (controllo temperatura di colore, solo per versioni con min. 3 lampade o versioni LED).	Luminaire available, on request, in CTC version (colour temperature control, only for versions with a min. of 3 lamps or LED versions).
	Apparecchio disponibile su richiesta in versione dimmerabile.	Luminaire available, on request, in dimmable version.
	Apparecchio disponibile, su richiesta, con schermo micropismaticizzato per elevato comfort visivo.	Luminaire available, on request, with micropismaticized screen for high visual comfort.
	Protezione Acqua Stop	Water Stop protection

Protezioni IP/IP Protection degree code

1° CIFRA - Protezione da corpi solidi/

- IP1... Protezione da corpi solidi $\geq 50\text{mm}$
- IP2... Protezione da corpi solidi $\geq 12\text{mm}$
- IP3... Protezione da corpi solidi $\geq 2,5\text{mm}$
- IP4... Protezione da corpi solidi $\geq 1\text{mm}$
- IP5... Protezione da polvere
- IP6... Protezione totale da polvere

1st DIGIT - Protection against solid bodies

- IP1... Protection against solid bodies $\geq 50\text{mm}$
- IP2... Protection against solid bodies $\geq 12\text{mm}$
- IP3... Protection against solid bodies $\geq 2,5\text{mm}$
- IP4... Protection against solid bodies $\geq 1\text{mm}$
- IP5... Protection against dust
- IP6... Total protection against dust

2° CIFRA - Protezione da acqua

- IP...1 Protezione da caduta di gocce verticali
- IP...2 Protezione da caduta di gocce con inclinazione di 15°
- IP...3 Protezione da spruzzi d'acqua con inclinazione di 60° dall'alto
- IP...4 Protezione dagli spruzzi d'acqua da ogni direzione
- IP...5 Protezione dai getti d'acqua
- IP...6 Protezione da inondazioni
- IP...7 Protezione contro l'immersione temporanea fino a $30'$ sotto 1m d'acqua
- IP...8 Protezione contro l'immersione continua sotto 1m d'acqua

















2nd DIGIT - Protection against water

- IP...1 Protection against vertically falling drops
- IP...2 Protection against vertically falling drops with a tilt angle up to 15°
- IP...3 Protection against sprays of water up to 60° from devertical
- IP...4 Protection against water spray from all directions
- IP...5 Protection against water jets
- IP...6 Protection against powerful water jets
- IP...7 Protection against temporary immersion up to $30'$ under 1m of water
- IP...8 Protection against continuous immersion under 1m of water

Tipologia di alimentazione/Power supply type



Marchi e requisiti/Certificates and requirements

	Apparecchio in classe prima con isolamento elettrico fondamentale. Deve essere collegato al circuito di terra dell'impianto elettrico generale.	Class I Luminaire with basic electrical insulation. It must be connected to the earth circuit of the general electrical system.
	Apparecchio in classe seconda con doppio isolamento elettrico. Non necessita di collegamento al circuito di terra dell'impianto elettrico.	Class II luminaire with double electrical insulation. There is no need for connection to the earth circuit of the electrical system.
	Apparecchio in classe terza predisposto per il collegamento a circuiti a bassissima tensione.	Class III luminaire suitable for connection to extra-low voltage circuits.
	Marchatura CE	CE Marking
	L'apparecchio può essere installato su superfici normalmente infiammabili.	The luminaire can be installed on normally flammable surfaces.
		
	ISO 9001	
	Ellissi di Macadam.	Macadam Ellipse.
	Resistenza al carico statico.	Static load resistance.
	Lunghezza del cavo di alimentazione in dotazione.	Length of supplied power cable.
	Uscita cavo di alimentazione L= Laterale P= Posteriore T= Testa	Cable Output L= Side P= Rear T= Head
	Protezione contro sbalzi di tensione	Protection against sudden changes in voltage.
	Protezione contro l'inversione di polarità	Reverse polarity protection.
	Rotazione dell'apparecchio sull'asse verticale.	Luminaire rotation on vertical axis.
	Inclinazione dell'apparecchio sull'asse orizzontale.	Luminaire inclination on horizontal axis.
	Tipo di emissione luminosa.	Type of light emission.

Resistenza agli urti/Shock resistance

	IK00 Non protetto/ No protection	IK03 0,35 J	IK07 2,00 J
	IK01 0,15 J	IK04 0,50 J	IK08 5,00 J
	IK02 0,20 J	IK05 0,70 J	IK09 10,00 J
		IK06 1,00 J	IK10 20,00 J

Condizioni generali/General Conditions

Le potenze ed i flussi luminosi indicati nel presente catalogo sono riferiti alle sorgenti LED.

Wattage and lumens indicated in this catalogue are referred to the LED sources.

Lam32 srl si riserva il diritto di apportare modifiche ai prodotti della collezione al fine di miglioramento o per esigenze di carattere tecnico e commerciale. Vi invitiamo a consultare il sito www.lam32.com per avere i dati continuamente aggiornati.

Lam32 Ltd reserves the right to make every changes to the products of the this collection, to improve the betterment, or to meet the technical and commercial needs. We invite you to visit the website www.lam32.com, as to have always the data updated.